

❖ FOUR POINT PROBE – SELECTION GUIDE

How do I choose the best SP4 or HT4 for my application?

SELECTING THE BEST 4 POINT PROBE HEAD FOR YOUR APPLICATION

Choosing the right probe head is a matter of selecting the best spring pressure, probe tip radius, material and probe tip spacing for your application. The following is a guide for making the best selection; however, experience has shown best results are achieved by using guidelines to select the initial probe head, then experimenting with different spring pressures or materials to match the characteristics of your application.

Spring Pressure: The spring pressure is the pressure used to force each individual probe tip onto the sample surface to make electrical or ohmic contact. Lucas Signatone offers 45 gram, 85 gram and 180 gram spring pressures for standard probe heads (SP4 series) for testing below temperatures of 90 degrees C. Probe heads for use at higher temperatures (the HT4 series) have 180 gram spring pressures. The physical characteristics of the sample determine the correct spring pressure as follows:

- A. For easily contacted films such as metal films or soft films such as conductive polymers or very thin films, start with the lowest spring pressure that gives satisfactory contact, usually 45 grams.
- B. For difficult to contact samples such as high resistivity silicon or similar materials which naturally form a nonconductive layer when exposed to an air ambient, start with the high spring pressure of 180 grams. Note: Nonconductive layers may form when samples experience high temperatures; therefore, HT4 high temperature probes use 180 gram spring pressures.
- C. For intermediate or unknown films start with an 85 gram spring pressure probe.

Probe Tip Radius: Lucas Signatone probe tips are micro-machined to have the shape of a section of a sphere at the tip. 1.6 mil, 5 mil, and 10 mil tip radii are available. Generally the large tip radius probes are more robust, but it is more difficult to make good electrical contact with these probes. Use the following guide for the selection of tip radius:

- A. For easily contacted films and thin films start with a 5 mil tip radius.
- B. For very thin films start with a 10 mil probe tip radius.
- C. All other applications start with the standard 1.6 mil probe tip radius.

Probe Tip Material: Signatone offers 4-point probes with tips of either Tungsten Carbide or Osmium. Tungsten Carbide is a crystalline material that is very hard and can be broken along the crystal boundaries with horizontal motion of the probe. Osmium is an amorphous material and is also hard, but is more forgiving to small horizontal motion. It is believed that Osmium will give longer performance or more touch downs than Tungsten carbide, but it is slightly more expensive

❖ FOUR POINT PROBE – SELECTION GUIDE

Also, Osmium has the physical characteristic (work function) such that it can make better contact with some exotic materials. The following is suggested:

- A. For laboratory and low volume usage start with Tungsten Carbide.
- B. For production environment probing or contacting many points on the sample consider Osmium. Also, consider trying Osmium to improve contact.

Probe Spacing: The probes have a constant spacing, S , between each of the 4 tips. Lucas Signatone products use software with correction algorithms allowing for probing near the edge of the sample (to within a proximity of $4 \times S$) with 1% accuracy. Generally larger probe tip spacings give better results. Please use the following guide.

- A. For samples with geometry greater than 0.5 inch in diameter use 0.0625 inch (62.5 mils) spacing.
- B. For smaller samples or for probing closer than 0.25 inch to the edge use 0.040 (1mm or 40 mils) spacing.

<http://www.fourpointprobe.com/applications/resistivity.asp>

\$\$\$ SP4 / HT4 Pricing \$\$\$

For pricing, please configure the part number by using the above information, then send us an e-mail at: Sales@Signatone.com

➤ **How do I clean the tips of my SP4?**

Regarding the SP4 there is really no sure way to clean the tips. We certainly discourage the use of any chemicals, solvents or touching the tips with a cloth in attempt to wipe them clean. The only method that we have used is compressing the tips 20-50 times on a ceramic surface but there is no specification for the outcome of this process or guarantee that this will clean the tips, as in most cases this does not work. If there is visible debris on the tips you can try using high pressure air to blow away the debris. The SP4 is disposable and priced to be easily replaced and most models are on the shelf for immediate shipment ARO.

❖ FOUR POINT PROBE – SELECTION GUIDE

The SP4 probe head is designed for use with Signatone and other resistivity probing systems for the measurement of thin films and materials.

The SP4 head has several configurations parameters permitting users to define the probe head best for their application.



➤ Spacing Between Tips

- 0.0625 inches (62)
- 0.050 inches (50)
- 0.040 inches (40)

➤ Pressure On Each Tip

- 45 grams (045)
- 85 grams (085)
- 180 grams (180)

➤ Probe Tip Material

- Osmium (O)
- Tungsten Carbide (T)

➤ Tip Radius

- 0.0016 inches [1.6mil] (R)
- 0.005 inches [5 mil] (F)
- 0.010 inches [10 mil] (B)

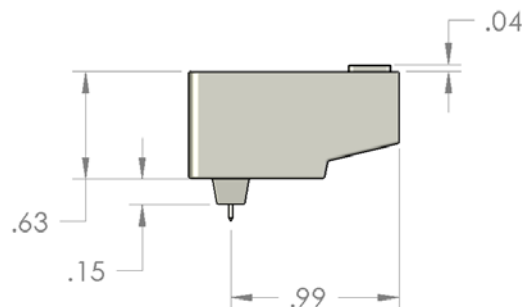
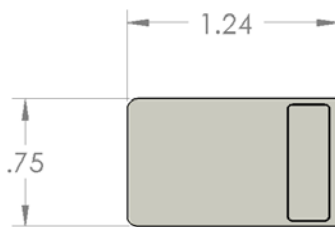

❖ Electrical Connection Options

- Flying lead termination, 15" wire (S)
- 9 pin D sub with 15" wire (Y)
- 9 pin D sub with 6" wire (Q)
- 4 36" wires with Banana Plugs (J) *
- 4 36" coax wires with BNC (N)*
- 2 36" coax wires with BNC (C)*
- 4 36" Triax wire with TRX (HT4) (X)*
- 2 8" Triax wire with TRX (HT4) (D)*

* for direct connection to various meters

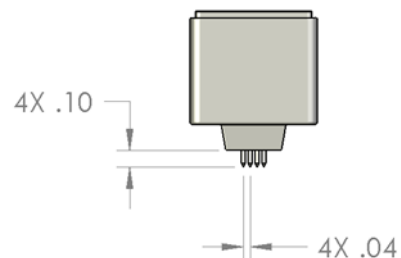
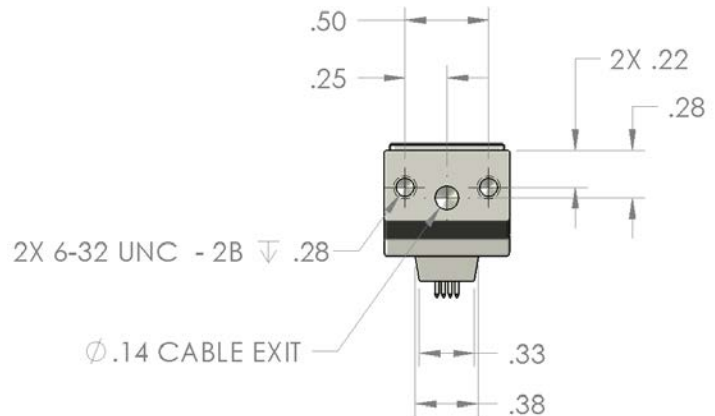

❖ FOUR POINT PROBE – MODEL MAKER

Standard Head (Delrin)

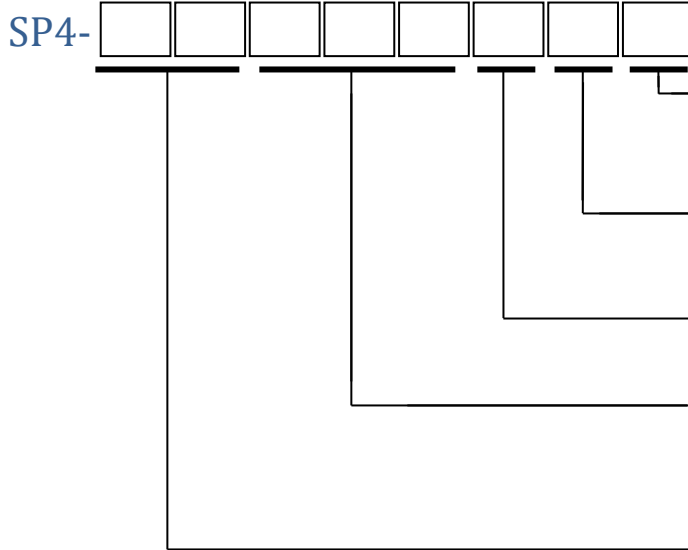

- S = Standard, flying lead termination
- Y = 15" wire, 9 pin D sub, for Pro4/S-302
- Q = 6" wire, 9 pin D sub, for QuadProII
- J = 36" wire with (4) Banana Plugs
- N = 36" Coaxial wire with 4 BNC
- R = 1.6 mil radius tip
- F = 5 mil radius tip
- B = 10 mil radius tip

- T = Tungsten Carbide
- O = Osmium

- 045 = 45 gram spring pressure
- 085 = 85 gram spring pressure
- 180 = 180 gram spring pressure

- 40 = 40 mil spacing between tips
- 50 = 50 mil spacing between tips
- 62 = 62.5 mil spacing between tips



SP4-62085TRY

Sample Part Numbers:

HT4-62180ORY

High Temperature or High Resistance Head (Macor)

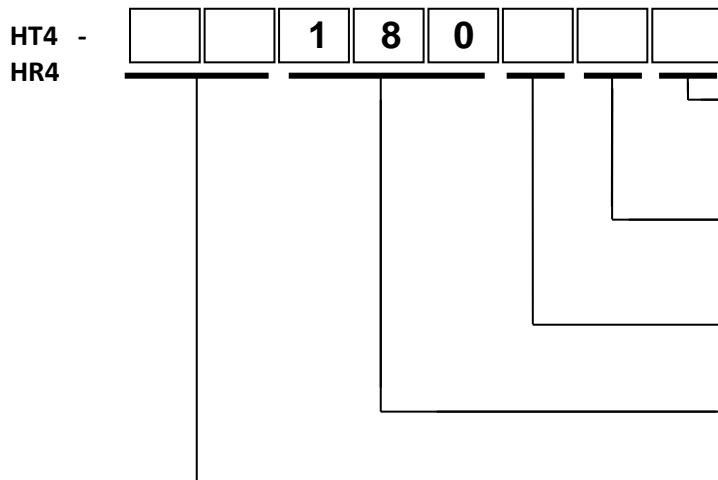

- S = Standard, flying lead termination
- Y = 15" wire, 9 pin D sub, for Pro4/S-302
- Q = 6" wire, 9 pin D sub, for QuadProII
- J = 36" wire with (4) Banana Plugs
- N = 36" Coaxial wire with 4 BNC connectors
- C = 36" Coaxial wire with 2 BNC connectors

- R = 1.6 mil radius tip
- F = 5 mil radius tip
- B = 10 mil radius tip
- T = Tungsten Carbide
- O = Osmium

- 180 = 180 gram spring pressure

- 50 = 50 mil spacing between tips
- 62 = 62.5 mil spacing between tips

❖ **FOUR POINT PROBE – MOUNTING OPTIONS**

L-4PQM Quick Mounting Block

Use the L-4PQM to mount the SP4 and HT4 probe heads to any late model Lucas / Signatone Corp. resistivity test stand.

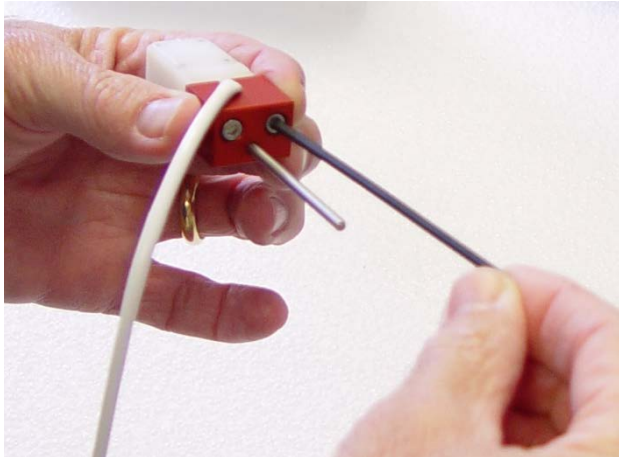

Back View
Mounting Holes

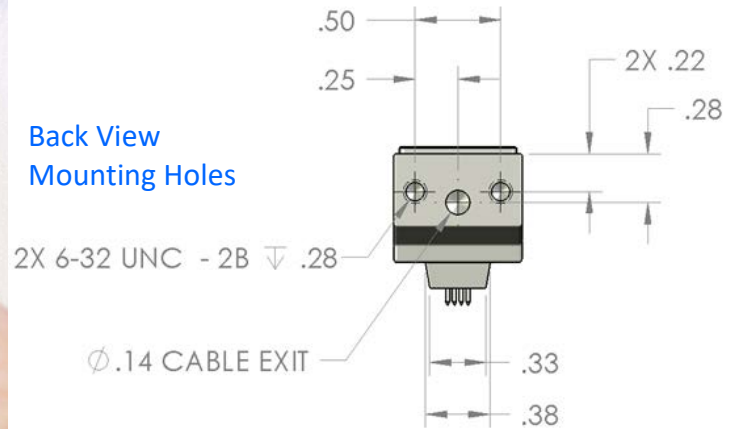

Use these dimensions to create your own mounting device.

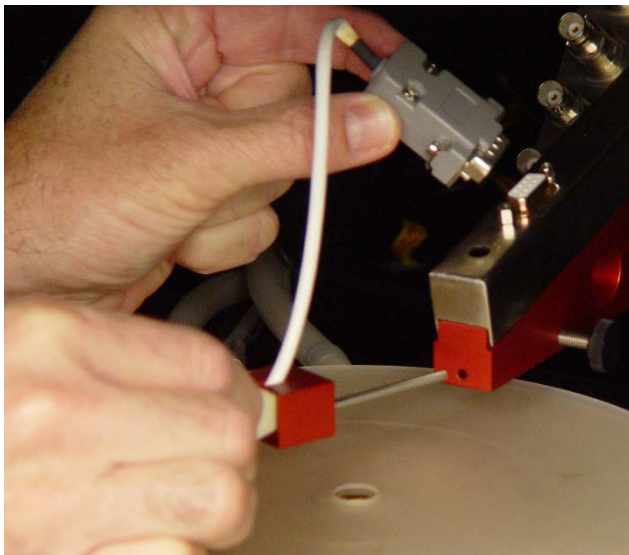
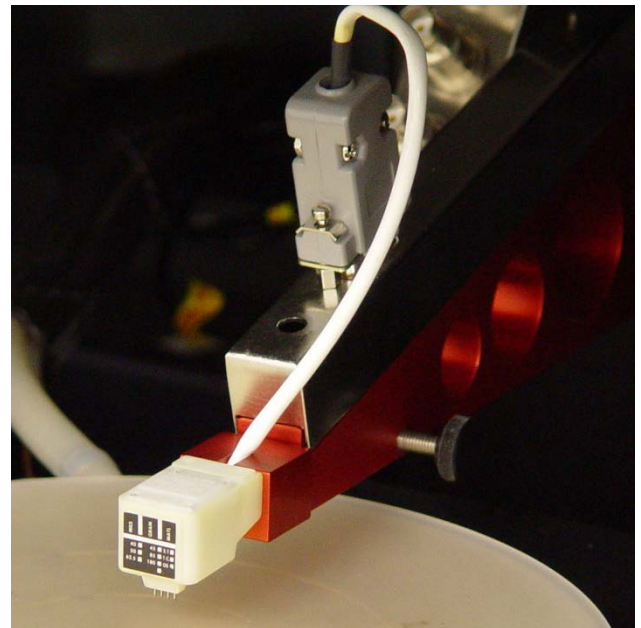
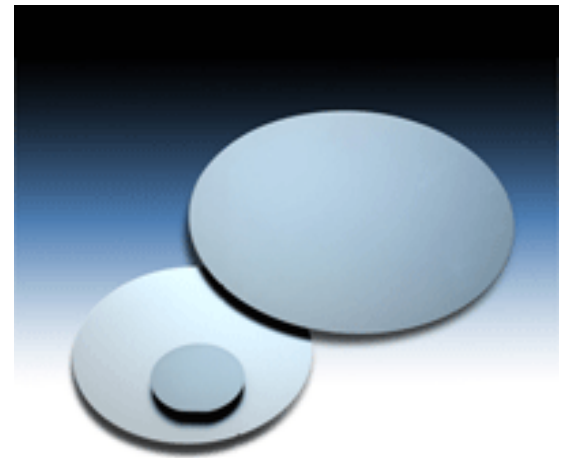

Photo: L-4PQM quick mounting block, holding SP4-62085TRQ mounted to our QuadProII S-A8 resistivity test station



❖ VLSI CALIBRATION STANDARDS (NIST TRACEABLE)

- Resistivity Standards (RS) span 4 decades and are designed for resistance calibration of contact resistivity measuring instruments. The resistance calibration standard is created by sawing a doped single crystalline ingot into wafers, lapping and chemically cleaning them to VLSI Standards' specifications.
- The resistance calibration standards are bare silicon wafers available in 76.2mm, 200mm, and 300mm sizes. The silicon is p-type (Boron) doped to nominal resistivity values, from 0.002 ohm.cm to 3 ohm.cm as available on the 3" model. For enhanced resistance calibration and measurement standard on contact probes, the wafers are lapped and chemically polished. The increased surface roughness allows cleaner penetration through the native oxide layer and better contact.
- Each wafer is certified at its center and traceable for accuracy. Certificates of Calibration are provided with each resistance calibration standard and report the resistivity, sheet resistance and thickness calibration and measurement values with calculated uncertainties.



The Resistivity Standard, available in three wafer sizes, 76.2mm, 200mm & 300mm (upon request)

| Wafer Size | Resistivity [Ohm.cm] | Sheet resistance [Ohms/Sq.] | Thickness | Signatone Part Number |
|----------------------------|----------------------|-----------------------------|-----------|-----------------------|
| 76.2 mm | 0.002 | 0.04 | 508 µm | SRS3-0.002 |
| 76.2 mm | 0.008 | 0.16 | 508 µm | SRS3-0.008 |
| 76.2 mm | 0.01 | 0.2 | 508 µm | SRS3-0.01 |
| 76.2 mm | 0.03 | 0.6 | 508 µm | SRS3-0.03 |
| 76.2 mm | 0.1 | 2 | 508 µm | SRS3-0.1 |
| 76.2 mm | 0.3 | 6 | 508 µm | SRS3-0.3 |
| 76.2 mm | 0.9 | 18 | 508 µm | SRS3-0.9 |
| 76.2 mm | 3 | 59 | 508 µm | SRS3-3 |
| 76.2 mm | 30 | 591 | 508 µm | SRS3-30 |
| 200 mm | | | | |
| 200 mm | 0.01 | 0.14 | 710 µm | SRS8-0.01 |
| 200 mm | 0.03 | 0.42 | 710 µm | SRS8-0.03 |
| 200 mm | 0.1 | 1.4 | 710 µm | SRS8-0.1 |
| 200 mm | 0.3 | 4.2 | 710 µm | SRS8-0.3 |
| 200 mm | 1 | 14 | 710 µm | SRS8-1 |
| 200 mm | 3 | 42 | 710 µm | SRS8-3 |
| 200 mm | 10 | 141 | 710 µm | SRS8-10 |
| 200 mm | 30 | 423 | 710 µm | SRS8-30 |
| 300 mm upon request | | | | |

IMPORTANT!

Calibration methods using Signatone’s RS test software included with our Pro4, QuadProII and ΩPro test systems are highly repeatable when used with these high-quality materials. When a VLSI, NIST traceable standard is used, the measurements may be set to correlate with the standard. Calibration should be done weekly or after changing probe heads. When performing calibration measurements with a 4-point-probe instrument, you must ensure that the probes and the silicon make solid, repeatable contact. Poor contact is revealed by a high standard deviation of multiple measurements taken from the same area or in some cases, zero-voltage readings.

Note: Typical delivery lead times for these wafers is 6-10 weeks and varies per product.

❖ Four Point Probe Theory

Resistivity, **Rho**, is a particularly important semiconductor parameter because it can be related directly to the impurity content of a sample; the four-point probe is the apparatus typically used to determine bulk Resistivity.

The mobility of the carriers depends upon temperature, crystal defect density, and ALL impurities present. Hall Effect Measurements can determine the mobility of the carriers in a given sample to allow for more accurate dopant concentration measurements, but Hall measurements are usually destructive to the sample.

The four-point probe contains four thin collinearly placed tungsten wire probes which are made to contact the sample under test. Current **I** is made to flow between the outer probes, and voltage **V** is measured between the two inner probes, ideally without drawing any current. If the sample is of semi-infinite volume and if the inter-probe spacing is **s1 = s2 = s3 = s**, then it can be shown that the Resistivity of the semi-infinite volume is given by:

$$\mathbf{Rho} = (\mathbf{\pi s}) \mathbf{V/I} \quad (1)$$

The subscription in the preceding equation indicates the measured value of the Resistivity and is equal to the actual value, **Rho**, only if the sample is of semi-infinite volume. Practical samples, of course, are of finite size. Hence, in general, **Rho ! = Rho**. Correction factors for six different boundary configurations have been derived by Valdes (1). These show that in general, if **l**, the distance from any probe to the nearest boundary, is at least 5s, no correction is required. For the cases when the sample thickness is 5s, we can compute the true Resistivity from:

$$\mathbf{Rho} = \mathbf{a 2 \pi s V/I} = \mathbf{Rho} \quad (2)$$

Where **a** is the thickness correction factor which is plotted (on page 3). From an examination of the plot we see that for values of **t/s >= 5** times the probe spacing, no correction factor is needed. Typical probe spacings are 25-60 mils and the wafers used in most cases are only 10-20 mils, so unfortunately, we cannot ignore the correction factor. Looking again at the plot, however, we see that the curve is a straight line for values of **t/s <= 0.5**. Since it is a log-log plot the equation for the line must be of the form:

$$\mathbf{a=K (t/s)^m} \quad (3)$$

where **K** is the value of **a** at **(t/s) = 1**, and **m** is the slope. Inspection of the plot shows that in this case **m = 1**. **K** is determined to be 0.72 by extrapolating the linear region up to the value at **(t/s) = 1**. (The exact value can be shown to be **1/(2 ln 2)**.) Hence for slices equal to or less than one half the probe spacing **a = 0.72 t/s**.

When substituted into the basic equation we get:

$$\mathbf{Rho} = \mathbf{a 2 \pi s V/I} = \mathbf{4.53 t V/I, (t/s) <= 0.5} \quad (4)$$

All samples we will be using in the lab satisfy the one-half relationship so we can use the above formula to determine **Rho**. We will perform Resistivity measurements on the starting material for each experiment. The value of **r** obtained will be referred to as the bulk Resistivity, and the units are Ohm-cm.

the end-to-end resistance of a rectangular sample. From the familiar resistance formula:

❖ Four Point Probe Theory continued:

$$R_s = \text{Rho}/t = 4.53 \text{ V}/I \text{ for } t/s \leq 0.5 \text{ (5)}$$

which we refer to as sheet resistance. When the thickness t is very small, as would be the case for a diffused layer, this is the preferred measurement quantity. Note that R_s is independent of any geometrical dimension and is therefore a function of the material alone. The significance of the sheet resistance can be more easily seen if we refer to the end-to-end resistance of a rectangular sample. From the familiar resistance formula:

$$R = \text{Rho } l/wt \text{ (6)}$$

we see that if $w = l$ (a square) we get:

$$R = \text{Rho}/t = R_s$$

Therefore, R_s may be interpreted as the resistance of a square sample, and for this reason the units of R_s are taken to be ohms-per-square or ohm/sq. Dimensionally this is the same as ohms but this notation serves as a convenient reminder of the geometrical significance of sheet resistance.

So far in our discussion of Resistivity measurements we have assumed that the size of our sample is large compared to the probe spacing so that edge effects could be ignored. This is usually the case for the bulk Resistivity measurement. However, our sheet resistance measurements will be made on a "test area" on our wafer and the test area dimensions (nominally 2.9 by 5.8mm) are not that large compared to the probe spacing (25 mils). In order to get accurate measurements, we will need to correct for the edge effects. In general, then:

$$R_s = C \text{ V}/I \text{ (7)}$$

where C is the correction factor. Note that for $d/s > 40$, $C = 4.53$, the value we had as the multiplier in Equation (5).

References: Valdes, L.G., Proc. I.R.E., 42,pp. 420-427 (February 1954) Smits, F. M., "Measurements of Sheet Resistivity with the Four Point Probe," BSTJ, 37, p. 371 (1958).

Same as BT Monograph, 3894, Part 2
Courtesy of: ECE344: Theory and Fabrication of Integrated Circuits
Electrical and Computer Engineering
University of Illinois – Urbana/Champaign

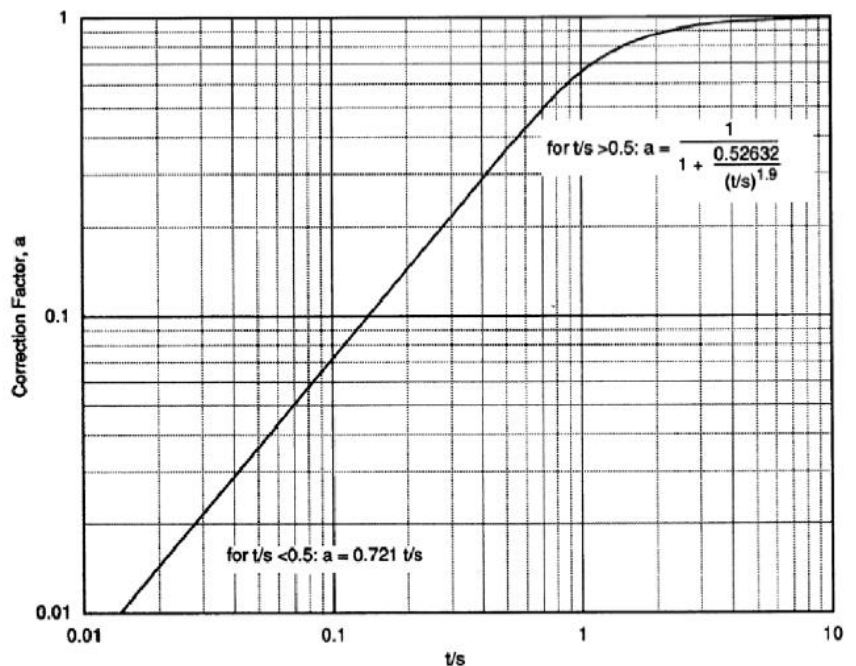

❖ **WARRANTY**

- Standard Warranty 12 months *
 - For Extended Warranty and Service Contracts : Contact Signatone Corp. for more information
- * See Signatone Corporate Terms and Conditions of Sale for further details.

Ask us about our family of Resistivity Test Equipment

Key features included in all Signatone systems include *Autorange* and *dual configuration*. *Autorange* automatically finds the ideal current setting to meet the parameters of the standard for measuring. At the first test site, the software controls the current source to step through a number of settings until the measured voltage is in target range as defined by the standard. This current is then used for all subsequent measurements of the sample. *Dual configuration* mode applies the standard ## to automatically correct for geometric errors caused by probe spacing and/or edge proximity improving overall accuracy.

Signatone offers Family of Products- The QuadProII for R&D and the Pro4 for basic, manual measurements, ΩPro - Resistance Testing System. Each family has a variety of options and configurations. With over 60 configurations to choose from, Signatone has the product that will meet your application.



Pro4
Resistivity Test System



QuadProII
Resistivity Test System



ΩPro
Resistance Testing System

- **North America:** Sales.NA@signatone.com
- **Europe:** Sales.Europe@signatone.com
- **Asia:** Sales.Asia@signatone.com

